



Table of Contents

Chapter 1: Product Overview	1
Package Contents	1
System Requirements	1
Hardware Overview	1
Chapter 2: Installation	3
Installation Overview	3
Hardware Installation.....	3
Connecting the Power.....	3
Chapter 3: Using the Camera Configuration Interface.	4
Navigation	4
Tools.....	5
Chapter 4: Main Tab	6
Status.....	6
Monitor.....	7
Chapter 5: Video Tab	9
Using a microSD Card	10
Video Settings.....	11
RTSP Authentication.....	11
Video Recording.....	11
SD Card	12
Chapter 6: Network Tab	14
Network Settings.....	14
TCP Explicit Congestion Notification	15
Advanced Ethernet Settings	15
Chapter 7: Services Tab	16
Ping Watchdog.....	16
SNMP Agent.....	17
Web Server.....	17
SSH Server	17
Telnet Server	17
NTP Client.....	18
Dynamic DNS	18
System Log.....	18

Chapter 8: System Tab	19
Device	19
Date Settings.....	19
System Accounts	19
Maintenance	20
Appendix A: Specifications	22
Appendix B: Safety Notices	23
Electrical Safety Information	23
Appendix C: Warranty	24
General Warranty.....	24
Appendix D: Compliance Information	25
Installer Compliance Responsibility	25
FCC	25
RF Exposure Warning	25
Industry Canada	25
CE Marking.....	25
RoHS/WEEE Compliance Statement.....	26
Appendix E: Declaration of Conformity	27
Appendix F: Contact Information	28
Ubiquiti Networks Support	28

Chapter 1: Product Overview

Thank you for purchasing the airCam Mini™, by Ubiquiti Networks. The airCam Mini is a professional-grade H.264 IP indoor camera that features 1MP/HDTV 720p/30 FPS capabilities and works in low-light and night-viewing environments.

This User Guide is designed to provide instructions about installation of the airCam Mini and to provide details about how to set up and use the camera configuration interface.

The airCam Mini includes the airVision™ software. airVision is a comprehensive camera management software solution from Ubiquiti Networks, Inc. that is designed to work with Ubiquiti's airCam product line. The software interface design is based on the popular and easy-to-use UniFi™ software interface.

The airCam Mini is equipped with an integrated microSD card writer. Using an optional microSD card (not included), audio and video can conveniently be captured and recorded simultaneously on the card and on an airVision-controlled hard drive. Recordings can be transferred and viewed on any computer or H.264 supported device.

For instructions on using the airVision software, refer to the documentation included on the CD-ROM. The airCam Mini supports Passive PoE which works with the included PoE adapter.

Package Contents



Camera



24V PoE Adapter



Power Cord



Quick Start Guide



airVision™ Software CD

System Requirements

- Microsoft Windows XP, Windows Vista, Windows 7, or Mac OS X
- Java Runtime Environment 1.6 (or above)
- Web Browser: Mozilla Firefox, Google Chrome, or Microsoft Internet Explorer 8 (or above)

Hardware Overview

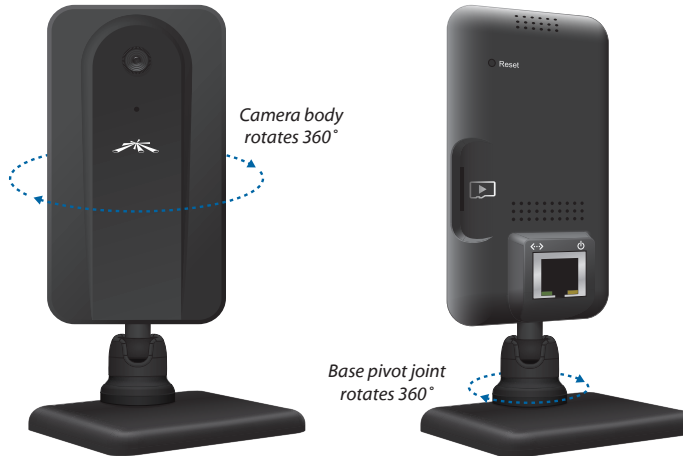
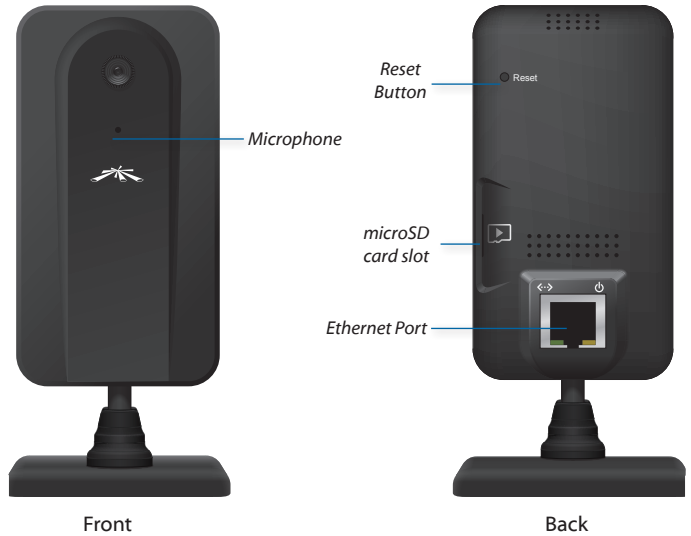

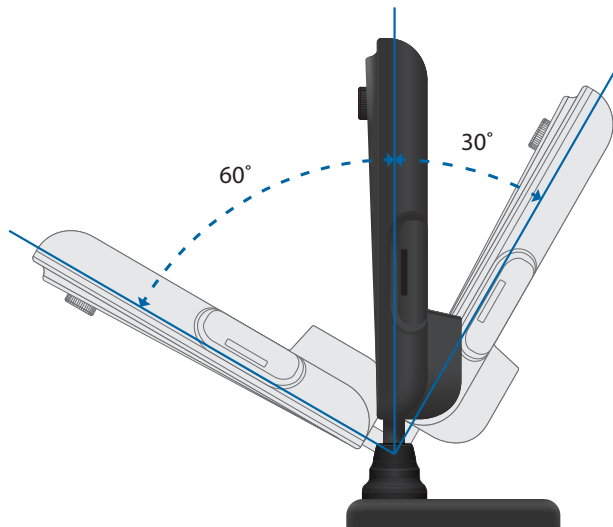

Camera can be angled to lean 60° forward or 30° backward.

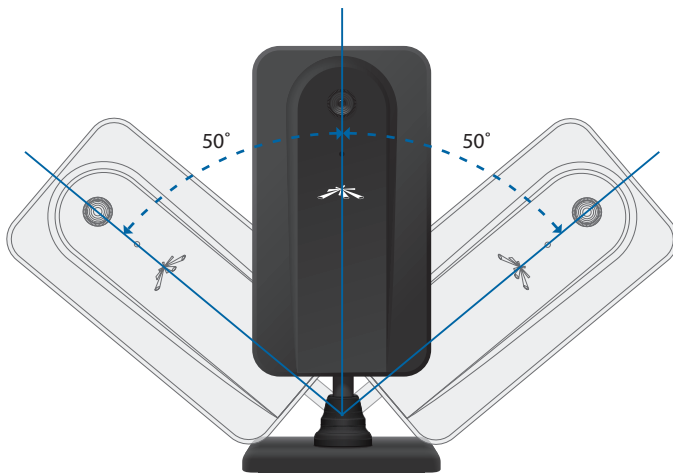

Maximum side-to-side tilt is 50° off vertical.

LEDs



↔ **Ethernet** The Ethernet LED will light steady green when an active Ethernet connection is made and flash when there is activity.

🔌 **Power** The Power LED will light steady orange when the airCam Mini is connected to a power source.



Note: LED operation may be disabled using the camera configuration interface.

Chapter 2: Installation

Installation Overview

Your airCam Mini is pre-assembled at the factory and is Plug and Play ready. If you do not plan on using the optional microSD recording feature, skip to Step 2.

Hardware Installation

1. (Optional) Insert a microSD card into the slot on the side of the camera until it locks into the slot.

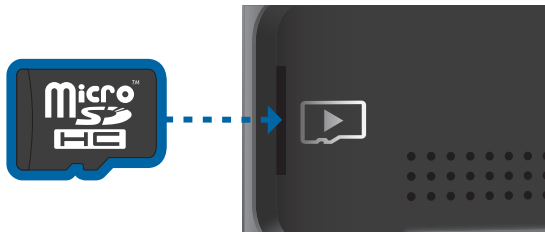

To remove the microSD card, push the card in to release the lock. Pull the card out.



Note: Before removing the microSD card, follow the steps under **“Removing the microSD Card”** on page 10.

2. Connect an Ethernet cable to the Ethernet port located on the back of the camera.



Connecting the Power

1. Connect the other end of the Ethernet cable to the Ethernet port labeled **POE** on the *PoE Adapter*.



2. Connect an Ethernet cable from your LAN to the Ethernet port labeled **LAN** on the *PoE Adapter*.



3. Connect the power cord to the power port on the *PoE Adapter*. Connect the other end of the power cord to a power outlet. The Power LED should light up on the airCam Mini.

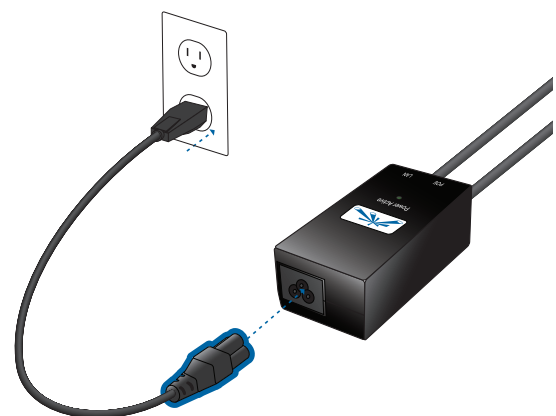

Hardware installation is complete.

Chapter 3: Using the Camera Configuration Interface

The airCam Mini has a browser-based *Camera Configuration Interface* for advanced camera management options. The Camera Configuration Interface is accessible from the airVision software by clicking on the **Hostname** of the camera in the *Device* tab. You can also access the interface without launching the airVision software as described below:

To access the interface, perform the following steps:

1. Make sure that your host machine is connected to the same LAN as the airCam Mini.
2. The airCam Mini is set to DHCP by default. If you have a router or DHCP server providing addresses on your network, check your DHCP Client Table to obtain the address of the airCam Mini or use the Device Discovery Tool available at:

www.ubnt.com/support/downloads/utilities



Note: If you do not have a DHCP server, the airCam Mini defaults to the IP address **192.168.1.20**.

3. Launch your Web browser and type **http://192.168.1.20** in the address field and press **Enter** (PC) or **Return** (Mac).



4. The login screen will appear. Enter **ubnt** in the *Username* and *Password* fields and click **Login**.

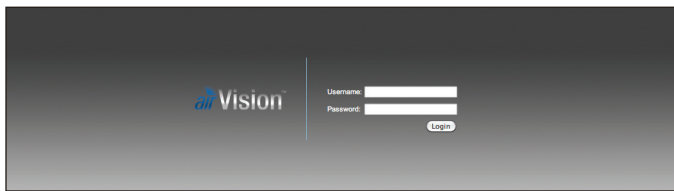

The airCam Mini configuration interface appears.

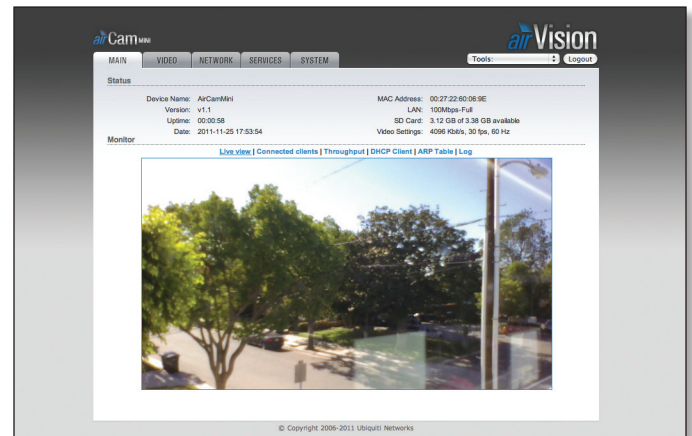

Navigation

The airCam Mini configuration interface contains five main tabs, each of which provides a web-based management page containing configurable parameters that affect a specific aspect of the airCam Mini:

- **Main** The *Main* tab displays airCam Mini status/statistical information and provides video and client monitoring links. For detailed information, refer to **“Main Tab” on page 6**
- **Video** The *Video* tab allows you to configure Video Settings including the Bit Rate, Quality, Frame Rate, and Refresh Frequency for the airCam Mini. For detailed information, refer to **“Video Tab” on page 9**
- **Network** The *Network* tab covers the configuration of the Network Settings, TCP Explicit Congestion Notification and Advanced Ethernet Settings. For detailed information, refer to **“Network Tab” on page 14**
- **Services** The *Services* tab covers the configuration of system management services including Ping Watchdog, SNMP Agent, Web Server, SSH Server, Telnet Server, NTP Client, Dynamic DNS, and System Log. For detailed information, refer to **“Services Tab” on page 16**
- **System** The *System* tab contains controls for airCam Mini Device Settings, Date Settings, System Accounts, Configuration Management and Device Maintenance. For detailed information, refer to **“System Tab” on page 19**

The airCam Mini configuration interface also contains network utility tools including:

- **Ping**
- **Traceroute**

Tools

Ping

The *Ping* tool is used to check the preliminary link quality and packet latency estimation between two network devices using ICMP packets.

The screenshot shows the 'Network Ping' configuration window. It includes a dropdown menu for 'Select Destination IP' with the option 'or specify manually' selected. There are input fields for 'Packet Count' (set to 5) and 'Packet Size' (set to 56). Below these is a table with columns for 'Host', 'Time', and 'TTL'. At the bottom, there are statistics: '0 of 0 packets received, 0% loss', 'Min: 0 ms', 'Avg: 0 ms', and 'Max: 0 ms'. A 'Start' button is located at the bottom right.

Network Ping

Select Destination IP A remote system IP can be selected from the list which is generated automatically or can be specified manually.

Packet Count Enter the number of packets to send for the ping test.

Packet Size The size of the ICMP packets can be specified in this field.

Start The test is started using this button.

Packet loss statistics and latency time evaluation is provided after the test is completed.

Traceroute

The *Traceroute* tool allows tracing the hops from the device to a selected outgoing IP address. It should be used for finding the route taken by ICMP packets across the network to the Destination host.

The screenshot shows the 'Network Traceroute' configuration window. It has a 'Destination Host' input field and a checkbox for 'Resolve IP Addresses'. Below is a table with columns for '#', 'Host', 'IP', and 'Responses'. A 'Start' button is located at the bottom right.

Destination Host Enter the IP address of the destination host to which you want to find the route.

Resolve IP Addresses Resolution of the IP addresses (symbolically rather than numerically) can be enabled by selecting this option.

Start The test is started using this button.

Chapter 4: Main Tab

The *Main* tab displays status/statistical information and provides video and client monitoring links.

Status

Status	
Device Name: AirCamMini	MAC Address: 00:27:22:60:06:9E
Version: v1.1	LAN: 100Mbps-Full
Uptime: 00:00:58	SD Card: 3.12 GB of 3.38 GB available
Date: 2011-11-25 17:53:54	Video Settings: 4096 Kbit/s, 30 fps, 60 Hz

Device Name Displays the name (ID) of the airCam Mini. The Device Name can be modified on the *System* tab.

Version Displays the version of the airVision software installed.

Uptime This is the total time the airCam Mini has been running since last power up (reboot) or software upgrade. The time is displayed in days, hours, minutes and seconds.

Date Displays the current system date and time. The date and time are displayed in YEAR-MONTH-DAY HOURS:MINUTES:SECONDS format. The system date and time is retrieved from the Internet using NTP (Network Time Protocol). The NTP Client is enabled by default on the *Services* tab. The device doesn't have an internal clock and the date and time may be inaccurate if the NTP Client is disabled or the device isn't connected to the Internet.

MAC Address Displays the Media Access Control (MAC) address of the airCam Mini.

LAN Indicates the current status of the Ethernet port connection. This can indicate when a cable is not plugged into a device or if there is no active Ethernet connection. When a cable is plugged in and connected properly to another device, the negotiated data rate and duplex are displayed.

SD Card Displays the amount of space used and the total capacity of the microSD card.

Video Settings Displays the bit rate, frame rate, and refresh frequency. These settings are editable on the *Video* tab. Refer to **"Video Settings" on page 11** for details.

Monitor

Live View

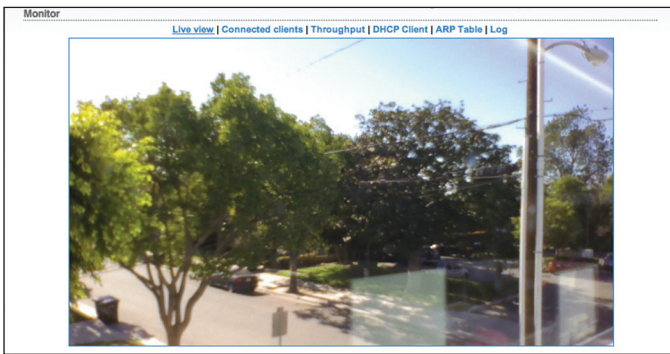

Displays a live video view based on the settings configured on the *Video* tab.

Camera Controls

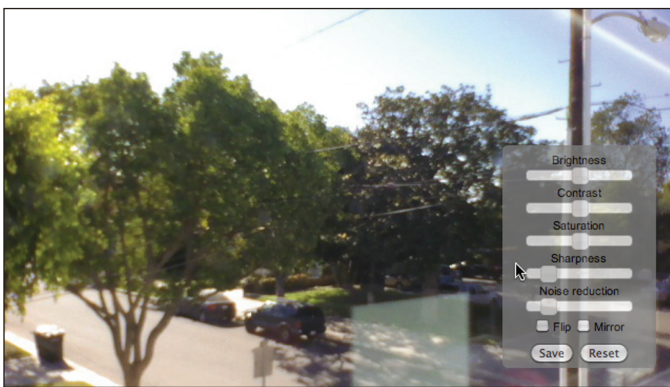

Camera controls appear when the mouse pointer is placed over the Live View image. Use the sliders to adjust the image settings.

Brightness Use the slider to adjust the image brightness.

Contrast Use the slider to adjust the image contrast.

Saturation Use the slide to adjust the color saturation of the image.

Sharpness Use the slider to adjust the image sharpness.

Noise Reduction Use the slider to adjust the noise reduction setting.

Flip Check this option to flip the image upside down.

Mirror Check this option to reverse the image horizontally.

Save Click to save the camera settings.

Reset Click to reset to the camera default settings.

Connected Clients

Protocol	IP Address	Port
rtsp	192.168.25.140	49239

Displays a list of clients that are currently viewing the video stream.

Protocol Displays the protocol being used to connect.

IP Address Displays the IP address of the client.

Port Displays the port being used by the client.

Throughput

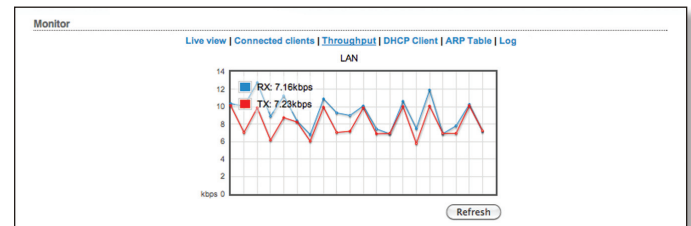

Throughput displays a visual representation of the current data traffic on the LAN port in both graphical and numerical form. The chart scale and throughput dimension (Bps, Kbps, Mbps) changes dynamically according to the mean throughput value. The statistics are updated automatically.

Refresh Throughput statistics can be updated manually by clicking **Refresh**.

DHCP Client

Shows the device's IP Address, Netmask, Gateway, DNS Servers, DHCP Server, Domain, Total Lease Time and Remaining Lease Time. DHCP Client mode can be enabled on the *Network* tab.

DHCP Client Information	
IP Address: 192.168.25.19	DHCP Server: 192.168.25.1
Netmask: 255.255.255.0	Domain: gateway.2wire.net
Gateway: 192.168.25.1	Total Lease Time: 1 day 00:00:00
Primary DNS IP: 192.168.25.1	Remaining Lease Time: 22:33:05
Secondary DNS IP:	

IP Address Displays the IP address of the airCam Mini while operating in DHCP Client mode. It is assigned automatically by the DHCP server.

Netmask Displays the netmask of the airCam Mini when operating in DHCP Client mode. It is assigned automatically by the DHCP server, which also assigns the IP address to the airCam Mini.

Gateway Displays the gateway of the airCam Mini when operating in DHCP Client mode, which is assigned automatically by the DHCP server.

Primary/Secondary DNS IP Domain Name System (DNS) is an Internet “phone book” which translates domain names to IP addresses. These fields identify the server IP addresses that the airCam Mini uses for translation. It is assigned automatically by the DHCP server.

DHCP Server Displays the IP address of the DHCP Server assigning the IP address to the airCam Mini.

Domain Displays the domain name.

Total Lease Time Shows the total time (validity) of the leased IP address assigned by the DHCP server.

Remaining Lease Time Displays the remaining time of the IP address leased by the DHCP server.

Renew DHCP client information can be renewed manually by clicking **Renew**.

Release DHCP client information can be released manually by clicking **Release**.

Refresh DHCP client information can be refreshed manually by clicking **Refresh**.

ARP Table

Lists all the entries of the Address Resolution Protocol (ARP) table currently recorded on the airCam Mini.

ARP is used to associate each IP address to the unique hardware Media Access Control (MAC) address of each device. It is important to have unique IP addresses for each MAC address or else there will be ambiguous routes in the network.

IP Address	MAC Address	Interface
192.168.25.1	3c:ea:4f:8a:91:29	LAN
192.168.25.123	10:9a:dd:ba:5a:7e	LAN

IP Address Displays the assigned IP address.

MAC Address Displays the Media Access Control (MAC) address of the device.

Interface Displays the interface that the device is on.

Refresh The information in the ARP Table window can be updated by clicking **Refresh**.

Log

Lists all registered system events. By default, logging is not enabled. The Log can be enabled on the *Services* tab.

```

System Log
Dec 31 16:00:07 system: Start
Dec 31 16:00:07 syslogd started: BusyBox v1.18.4
Dec 31 16:00:07 init: starting pid 215, tty '/dev/null': '/sbin/udhcpd -f -i eth0 -s /etc/udhcpd/udhcpd
Dec 31 16:00:07 init: starting pid 217, tty '/dev/null': '/bin/lighttpd -D -f /etc/lighttpd.conf'
Dec 31 16:00:08 init: starting pid 223, tty '/dev/null': '/bin/telnetd -P -p 23'
Dec 31 16:00:08 init: starting pid 228, tty '/dev/null': '/bin/dropbear -P -d /etc/persistent/dropbear_
Dec 31 16:00:08 route: add default gw 192.168.1.1 failed (error: 1]
Dec 31 16:00:08 init: starting pid 235, tty '/dev/null': '/sbin/ntpdclient -n -s -c 0 -l -h time.apple.c
Dec 31 16:00:08 init: starting pid 236, tty '/dev/null': '/bin/ubnt-streamer'
Dec 31 16:00:09 dropbear[228]: Not backgrounding
Dec 31 16:00:09 route: del default gw 192.168.1.1 failed (error: 1]
Dec 31 16:00:09 route: add default gw 192.168.1.1 failed (error: 1]
  
```

Clear All entries in the system log can be deleted by clicking **Delete**.

Refresh System Log content can be updated by clicking **Refresh**.

airCam MINI **airVision**

MAIN VIDEO NETWORK SERVICES SYSTEM Tools: [] Logout

Video Settings **RTSP Authentication**

Bit Rate, Kbit/s:
 Frame Rate, fps:
 Refresh Frequency, Hz:

Enable RTSP Authentication:
 Username:
 Password: Show

Video Recording

Off Continuous Record Scheduled Record Motion Record



Sensitivity **90**

SD Card

3.38 GB of 3.38 GB available

Search:

<input type="checkbox"/>	Name	Size, MB	Date
<input type="checkbox"/>	Rec_0000004.avi	1.81	Fri Nov 18 2011 16:35:34 GMT-0800 (PST)
<input type="checkbox"/>	Rec_0000003.avi	1.69	Fri Nov 18 2011 16:35:08 GMT-0800 (PST)
<input type="checkbox"/>	Rec_0000002.avi	1.72	Fri Nov 18 2011 15:51:08 GMT-0800 (PST)

Showing 1 to 3 of 3 entries

<< < 1 > >>

© Copyright 2006-2011 Ubiquiti Networks

Chapter 5: Video Tab

The *Video* tab allows you to configure basic Video Settings including the Bit Rate, Quality Frame Rate, and Refresh Frequency settings for the airCam Mini. If you are using an optional microSD card (not included), you can configure Video Recording and SD card options from this screen.

Using a microSD Card

You can record video on a microSD card. The recording options for recording on the microSD card are completely separate from the airVision software recording options. microSD card recording is configurable only in the Camera Configuration Interface.

If you haven't already, insert a microSD card into the slot on the side of the camera until it locks into the slot.

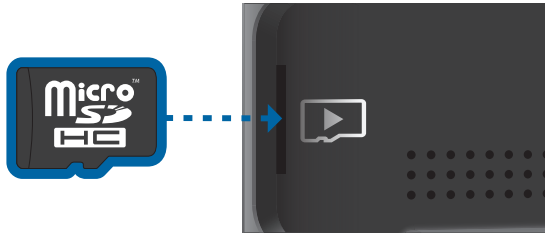

To remove the microSD card, push the card in to release the lock. Pull the card out.



Note: Before removing the microSD card, use the *Remove Memory Card* option on the *Video* tab.

Formatting the microSD Card

1. Go to the **Video** tab.
2. Click **Format Memory Card**.

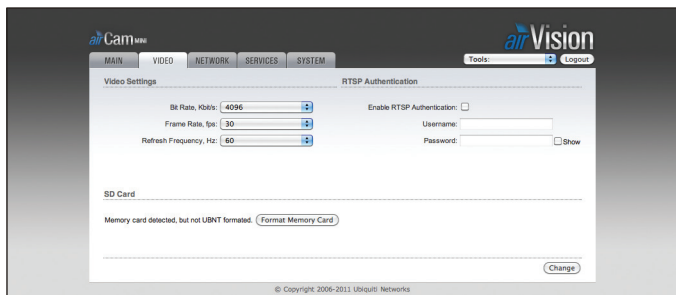

3. You will be prompted to confirm. Click **OK**.

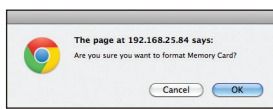

4. A message stating *Memory card formatted* will appear. Click **OK**.

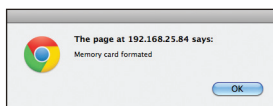

Removing the microSD Card

1. Go to the **Video** tab.
2. Click **Remove Memory Card**.

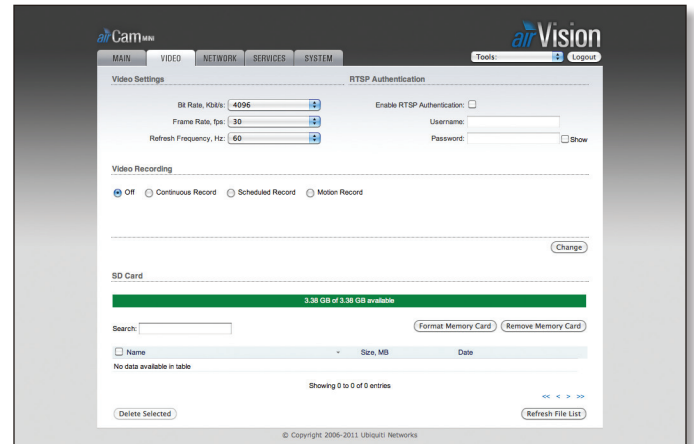

3. You will be prompted to confirm. Click **OK**.

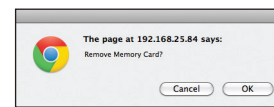

4. Click **OK**. You can now safely remove the memory card.



Mounting the microSD Card

If you have removed the microSD Card via the *Camera Configuration Interface* but have not physically removed the card from the camera, you can mount the card again by performing the following steps:

1. Go to the **Video** tab.
2. Click **Mount**.

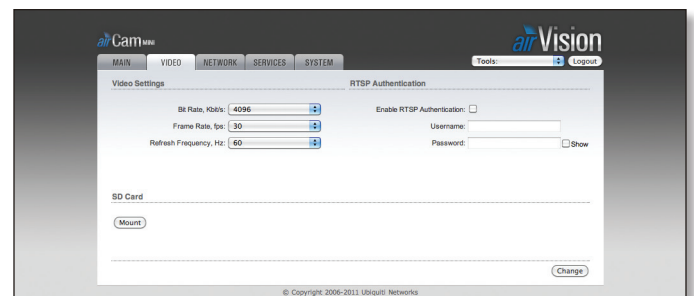

Video Settings

Bit Rate, Kbit/s This option allows the selection of the bit rate in kilobits per second. Options include 256, 512, 1024, 2048, 4096.

Frame Rate, fps This option allows the selection of the video frame rate in frames per second. Options include 2, 3, 4, 5, 7, 10, 15, 20, 25, 30.

Refresh Frequency, Hz This option allows the selection of the video refresh frequency in hertz. Options include 50 Hz and 60 Hz.

RTSP Authentication

Enable RTSP Authentication When RTSP (Real-Time Streaming Protocol) Authentication is enabled, a username and password is required to view video streams.

Username Enter a username for RTSP authentication.

Password Enter a password for RTSP authentication.

Video Recording

Once you have inserted and formatted a microSD card, the *Video Recording* and *SD Card* options will appear. These options are completely separate from the airVision recording options. The options that are configured here apply only to microSD card recording.

Off

When this option is set to Off, nothing is recorded on the microSD card. You can still use the camera for recording within the airVision software. Any recordings that are created in airVision will be recorded to the hard drive that the airVision NVR software is using.

Continuous Record

Enables continuous recording on the Micro SD card.

Scheduled Record

Days of the Week	Time	Status	Mon	Tue	Wed	Thu	Fri	Sat	Sun
Mon., Tue., Wed., Thu., Fri.	08:00 - 17:00	Disabled	<input checked="" type="checkbox"/>	<input checked="" type="checkbox"/>	<input checked="" type="checkbox"/>	<input checked="" type="checkbox"/>	<input checked="" type="checkbox"/>	<input type="checkbox"/>	<input type="checkbox"/>
Mon., Tue., Wed., Thu., Fri.	08:00 - 17:00	Disabled	<input type="checkbox"/>	<input type="checkbox"/>	<input type="checkbox"/>	<input type="checkbox"/>	<input type="checkbox"/>	<input type="checkbox"/>	<input type="checkbox"/>
Mon., Tue., Wed., Thu., Fri.	08:00 - 17:00	Disabled	<input type="checkbox"/>	<input type="checkbox"/>	<input type="checkbox"/>	<input type="checkbox"/>	<input type="checkbox"/>	<input type="checkbox"/>	<input type="checkbox"/>

Allows you to define a schedule for recording. Select which days that you want scheduled recording enabled and a start and end time.

Creating a Scheduled Recording

1. Select **Scheduled Record**.
2. Click **Add New Row**.
3. Select the days of the week that you want recording enabled by placing a check mark underneath the day.
4. Enter the start time and stop time in 24-hour format.
5. Select **Enabled**.
6. Click **Set**.
7. Click **Change**.
8. Click **Apply**.

Deleting a Scheduled Recording

1. Click on an existing row.
2. Click **Delete**.
3. Click **Yes** when prompted "Are you sure you want to delete schedule event?"

4. Click **Change**.
5. Click **Apply**.

Motion Record

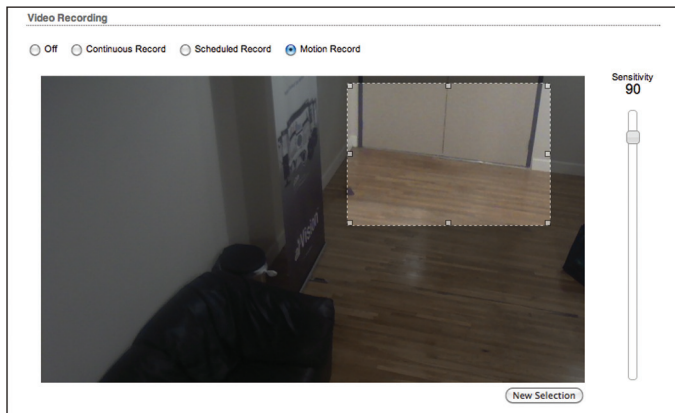

Select Full Frame Selects the entire camera frame for motion detection.

New Selection Allows you to select a specific area of the frame for motion detection. Click and hold the area of the image that you want to select. Drag and adjust the box to select the area where you want to detect motion.

Sensitivity Use the slider to adjust the sensitivity of the motion detection. Sensitivity values range from 100 to 1. Higher numbers increase the sensitivity, requiring less motion to trigger a recording.

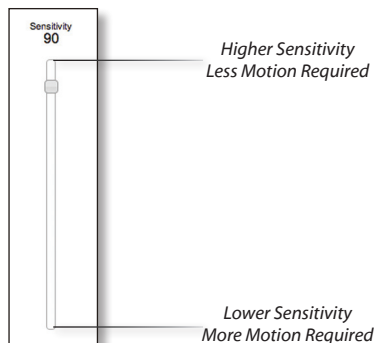

Enabling Motion Recording

1. Select **Motion Record**.
2. Click **New Selection** (or **Select Full Frame** to select the entire image).
3. To define the motion detection area, click and drag to create the motion detection frame. To adjust the size of the frame, place the mouse over a mid or end point and then click and drag. To move the frame position, click and drag an area of the motion detection frame that is not a mid or end point.
4. Select the *Sensitivity* level. Higher numbers increase the sensitivity, requiring less motion to trigger a recording.
5. Click **Change**.
6. Click **Apply**.

SD Card

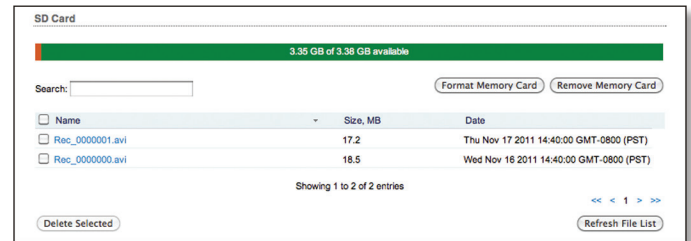

X of X available Displays the amount of space used and the total capacity of the microSD card.

Search Allows you to search recordings for specific search criteria. Any text that is entered is used as real-time search criteria and anything that doesn't match the entered characters will be removed from the view. Delete the search string to return to a normal view.

Format Memory Card Use this option to format a new microSD card.

Remove Memory Card Use this option to safely remove a microSD card.

Name Displays the name of the recording. Place the cursor over the file name to see a preview image from the recording. Double-click the name to download the file to your computer. Once the file downloads to the computer you can open it with a video player that supports .avi files.



Size Displays the size of the recording.

Date Displays the date and time that the recording took place.

Delete Selected Permanently deletes selected recordings.

Refresh File List Use to refresh the list of recordings to show any newly created recordings.

Video Playback

Videos recorded on the microSD card are recorded in .avi (Audio Video Interleave) format. Below are instructions on playing the files, based on your operating system.

Mac

1. Click on a file name from the list to download the file to your computer.

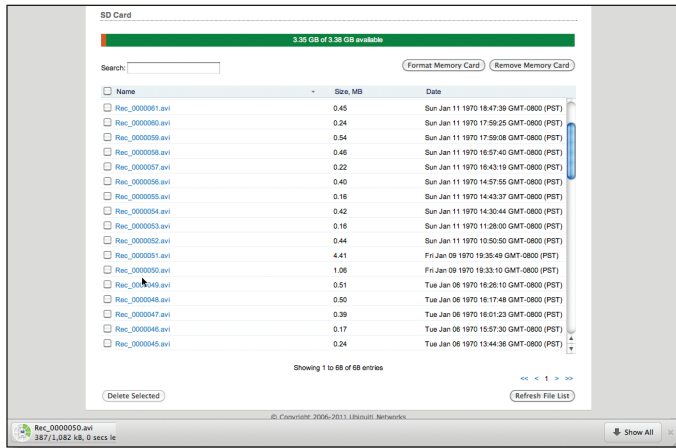

2. Launch a video player that supports the .avi format such as VLC media player (www.videolan.org/vlc/).
3. Go to **File** and select **Open File**.

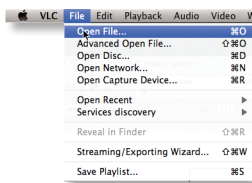

Note: If you are using the default browser file download preferences, the video file will be saved to the following location:
Macintosh HD/Users/<username>/Downloads

4. Double-click the file to open the downloaded file.

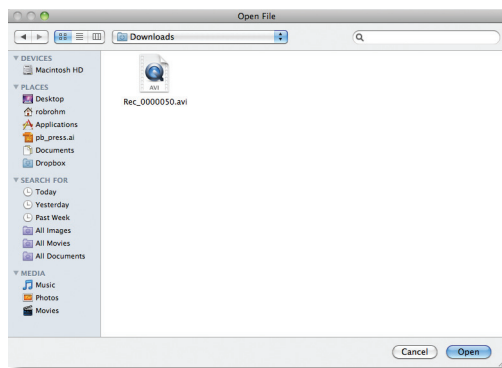

PC

1. Click on a file name from the list to download the file to your computer.

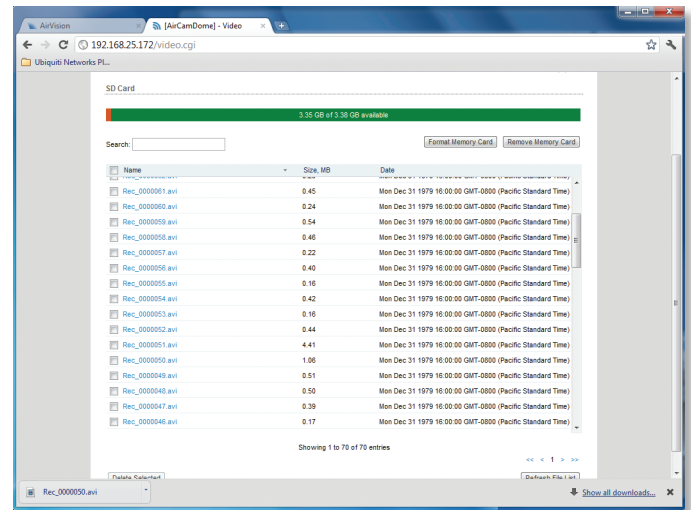

2. Once the file has downloaded, click to open the file in Windows Media Player.

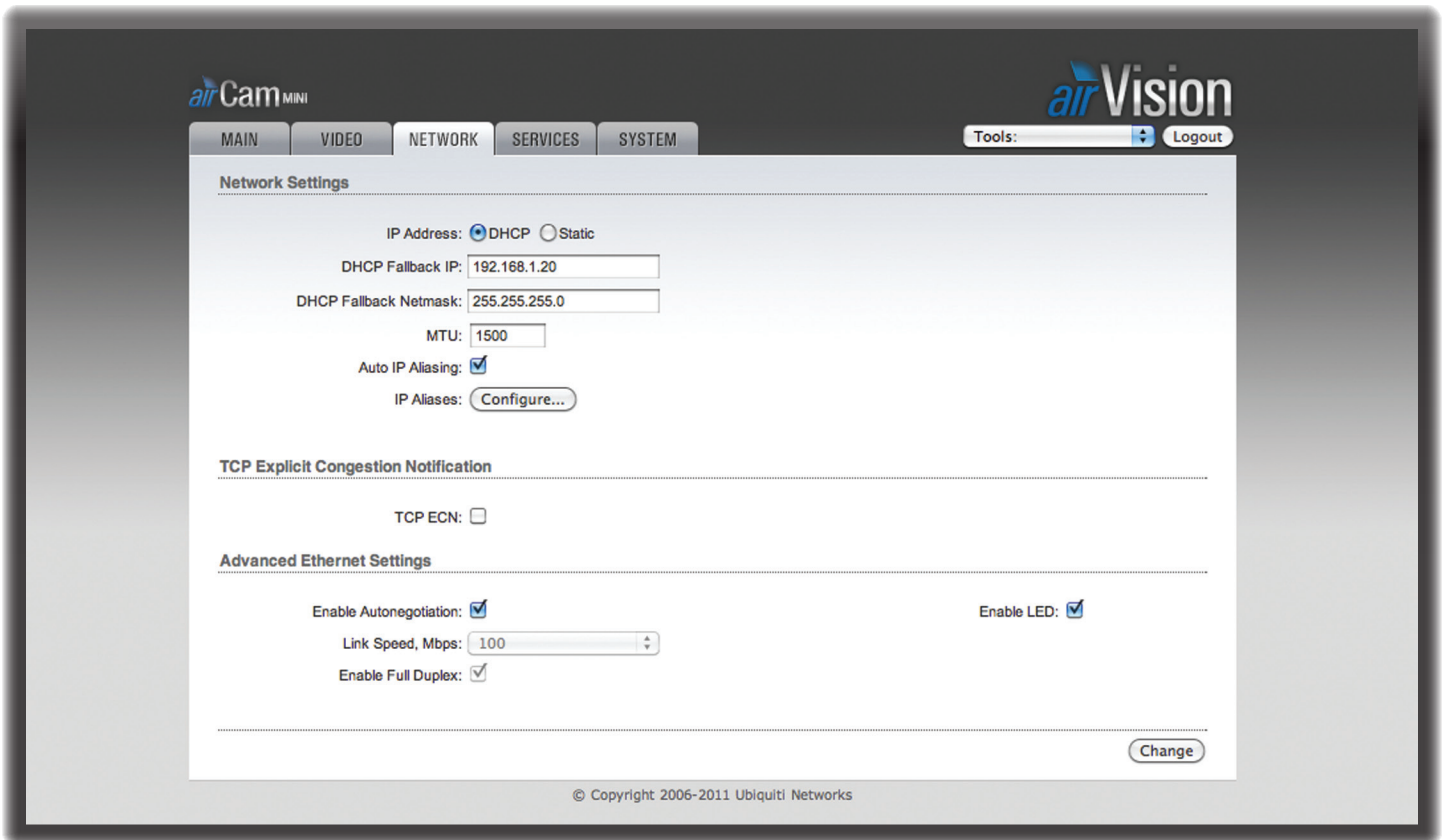

Chapter 6: Network Tab

The *Network* tab covers the configuration of the Network Settings, TCP Explicit Congestion Notification, and Advanced Ethernet Settings.

Network Settings

IP Address The airCam Mini can obtain an IP address automatically from a DHCP server or be configured with a static IP address. By default, the camera looks to obtain an IP address automatically. If the airCam Mini doesn't obtain an IP address from a DHCP server, the default DHCP Fallback IP of 192.168.1.20 is assigned to it.

- **DHCP** Choose this option to obtain a dynamic IP Address, Netmask, Gateway and DNS address from the local DHCP server.

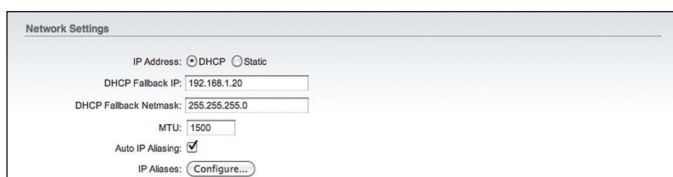

- **DHCP Fallback IP** Enter an IP address for the airCam Mini to use if a DHCP server is not found.
- **DHCP Fallback Netmask** Enter the Netmask for the airCam Mini to use if a DHCP server is not found.

- **Static** Select this option to assign a static IP address to the airCam Mini.

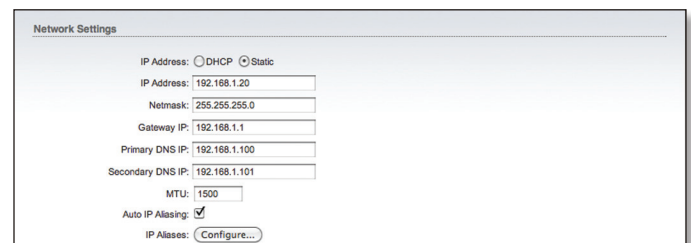

Note: IP Address and Netmask settings should be consistent with the address space of the network segment where the device resides.

- **IP Address** Enter the IP address of the airCam Mini. This IP will be used for device management purposes.
- **Netmask** This is a value which when expanded into binary provides a mapping to define which portions of IP address groups can be classified as host devices and network devices. Netmask defines the address space of the network segment where the device resides. 255.255.255.0 (or /24) Netmask is commonly used on many C Class IP networks.
- **Gateway IP** Typically, this is the IP address of the host router which provides the point of connection to the Internet. This can be a DSL Modem, Cable Modem, or a WISP Gateway Router. The airCam Mini will direct the packets of data to the gateway if the destination host is not within the local network.

- **Primary DNS IP** Enter the IP address of the Primary DNS (Domain Name System) server.
- **Secondary DNS IP** Enter the IP address of the Secondary DNS (Domain Name System) server. This entry is optional and only used if the primary DNS server is not responding.

MTU Enter the size (in bytes) of the largest protocol data unit the layer can pass on. When using slow links, large packets can cause some delays thereby increasing lag and latency. By default, the MTU is set to 1500 bytes.

Auto IP Aliasing Automatically generates an IP Address for the corresponding LAN interface if enabled. The generated IP address is a unique Class B IP address from the 169.254.X.Y range (Netmask 255.255.0.0) which is intended for use within the same network segment only. Auto IP always starts with 169.254.X.Y while X and Y are last 2 digits from the MAC address of the device (i.e. if the MAC is 00:15:6D:A3:04:FB, Generated unique Auto IP will be 169.254.4.251).

IP Aliases IP aliases for the internal and external network interface can be configured. IP Aliases can be specified using the *LAN IP Aliases* configuration window which is opened when you click **Configure**.

IP	Netmask	Comment	Enabled
1.			<input type="checkbox"/>
2.			<input type="checkbox"/>
3.			<input type="checkbox"/>
4.			<input type="checkbox"/>
5.			<input type="checkbox"/>
6.			<input type="checkbox"/>
7.			<input type="checkbox"/>
8.			<input type="checkbox"/>

Save Cancel

- **IP** The alternative IP address for the LAN interface, which can be used for the routing or device management purposes.
- **Netmask** The network address space identifier for the particular IP Alias.
- **Comments** Field used for a brief description of the purpose of the IP Alias.
- **Enabled** Enables or disables the particular IP Alias. All added IP Aliases are saved in the system configuration file, however only the enabled IP Aliases are active on the device.

Newly-added IP Aliases can be saved by click the **Save** button or discarded by clicking the **Cancel** button in the *LAN IP Aliases* configuration window.

TCP Explicit Congestion Notification

Transmission Control Protocol (TCP) Explicit Congestion Notification (ECN) can be enabled by selected **TCP ECN**.

TCP Explicit Congestion Notification

TCP ECN:

When enabled, TCP ECN reduces the number of packets dropped by the TCP connection. By avoiding a retransmission, this results in reduced latency and jitter.



Note: ECN is an optional feature that must be supported and enabled on both endpoints. TCP ECN is disabled on the airCam Mini by default.

Advanced Ethernet Settings

Advanced Ethernet Settings

Enable Autonegotiation: Enable LED:

Link Speed, Mbps: 100

Enable Full Duplex:

Enable Autonegotiation When enabled, the airCam Mini will automatically negotiate transmission parameters with the counterpart, such as Link Speed and Duplex. In this process, the connected devices first share their capabilities as for these parameters and then choose the fastest transmission mode they both support. To specify these values manually, clear the *Enable Autonegotiation* check box and select the appropriate values below.

Enable LED Selection turns LED next to the internal Ethernet port on or off.

Link Speed, Mbps Selects the maximum transmission link speed. There are two options: 10Mbps or 100Mbps. If running extra long Ethernet cables, a link speed of 10Mbps could help to achieve better stability.

Enable Full Duplex Selects the duplex mode; if enabled, the device operates in Full Duplex (allowing bidirectional communication in both directions simultaneously). While disabled, the device operates in Half-Duplex mode (allowing bidirectional communication in both directions, but not simultaneously and only in one direction at a time).

Chapter 7: Services Tab

The *Services* tab covers the configuration of system management services including Ping Watchdog, SNMP Agent, Web Server, SSH Server, Telnet Server, NTP Client, Dynamic DNS, and System Log.

Ping Watchdog

Ping Watchdog sets the airCam Mini to continuously ping a user defined IP address (it can be the Internet gateway for example). If it is unable to ping under the user defined constraints, the airCam Mini will automatically reboot. This option creates a kind of “fail-proof” mechanism.

Ping Watchdog is dedicated for continuous monitoring of the particular connection to remote host using the Ping tool. The Ping works by sending ICMP “echo request” packets to the target host and listening for ICMP “echo response” replies. If the defined number of replies is not received, the tool reboots the airCam Mini.

Enable Ping Watchdog Enables the Ping Watchdog tool.

- **IP Address To Ping** Specify the IP address of the target host which to be monitored by the Ping Watchdog tool.
- **Ping Interval** Specify time interval (in seconds) between the ICMP “echo requests” are sent by the Ping Watchdog Tool. The default value is 300 seconds.

- **Startup Delay** Specify initial time delay (in seconds) until the first ICMP echo requests are sent by the Ping Watchdog tool. The default value is 300 seconds.
The value of Startup Delay should be at least 60 seconds as the network interface and wireless connection initialization takes a considerable amount of time if the airCam Mini is rebooted.
- **Failure Count to Reboot** Specify the number of ICMP echo response replies. If the specified number of ICMP echo response packets is not received continuously, the Ping Watchdog tool will reboot the airCam Mini. The default value is 3.

SNMP Agent

Simple Network Monitor Protocol (SNMP) is used in network management systems to monitor network-attached devices for conditions that warrant administrative attention. The airCam Mini contains an SNMP agent which allows it to communicate to SNMP manage applications for network provisioning.

The SNMP Agent provides an interface for device monitoring using the Simple Network Management Protocol (an application layer protocol that facilitates the exchange of management information between network devices). SNMP Agent allows network administrators to monitor network performance, find and solve network problems. For the purpose of equipment identification, it is always a good idea to configure SNMP agents with contact and location information:

Enable SNMP Agent Select to enable the SNMP Agent.

- **SNMP Community** Specify the SNMP community string. It is required to authenticate access to MIB objects and functions as an embedded password. The airCam Mini supports a Read-only community string that gives read access to authorized management stations to all the objects in the MIB except the community strings, but does not allow write access. The airCam Mini supports SNMP v1. The default SNMP Community is *public*.
- **Contact** Specify the contact who that should be notified in case an emergency situation arises.
- **Location** Specify the physical location of the airCam Mini.

Web Server

The following Web Server parameters can be configured:

Use Secure Connection (HTTPS) If checked Web server will use secure HTTPS mode. HTTPS mode is unchecked by default.

- **Secure Server Port** Defines the Web Server TCP/IP port *Use Secure Connection (HTTPS)* is enabled.

Server Port Web Server TCP/IP port setting while using HTTP mode.

Session Timeout Specifies the maximum timeout before the session expires. Once a session expires, you must login again using the username and password.

SSH Server

The following SSH Server parameters can be configured:

Enable SSH Server This option enables SSH access to the airCam Mini.

- **Server Port** SSH service TCP/IP port setting.
- **Enable Password Authentication** When enabled, you must authenticate using Administrator credentials in order to grant SSH access to the airCam Mini, otherwise an Authentication Key will be required.
- **Authorized Keys** Click **Edit** to import a public key file working to get SSH access to the airCam Mini instead of using an admin password. To do so, perform the following steps:
 1. Click **Choose File** to locate and select the key file, then click **Import**.
 2. Click **Save** to save your changes or **Close** to discard your changes.

Telnet Server

The following Telnet Server parameters can be set:

Enable Telnet Server This option activates the Telnet access to the airCam Mini.

- **Server Port** Telnet service TCP/IP port setting.

NTP Client

The *NTP (Network Time Protocol) Client* option allows the airCam Mini to synchronize the time over the Internet from a network time server. Using this option helps to ensure accurate time for recordings, schedules, and logs.

Enable NTP Client Enables the airCam Mini to obtain the system time from a time server on the Internet.

- **NTP Server** Specify the IP address or domain name of the NTP Server.

Dynamic DNS

Enable Dynamic DNS Select this check box to enable Dynamic DNS service for the airCam Mini. Dynamic DNS is a network service providing which allows real-time notification to the DNS Server of any changes occurring in the airCam Mini's IP setting, there by allowing access to the airCam Mini through a Domain Name even if the airCam Mini's IP address has changed.

Host Name Defines the Dynamic DNS Host Name. A large list of Dynamic DNS services is available here.

Username Defines the Dynamic DNS Username.

Password Defines the Dynamic DNS password. Select **Show** to display the password.

System Log

Enable Log This option enables the registration routine of the system log messages. By default it is disabled.

- **Enable Remote Log** Enables the syslog remote sending function while System log messages are sent to a remote server specified in the *Remote Log IP Address* and *Remote Log Port* fields.
 - **Remote Log IP Address** The host IP address where syslog messages should be sent. Remote host should be configured properly to receive syslog protocol messages.
 - **Remote Log Port** The TCP/IP port of the host syslog messages should be sent. *514* is the default port for the commonly used system message logging utilities.

Every logged message contains at least a System Time and a Host Name. Usually a particular service name which generates the system event is specified also within the message. Messages from different services have different context and different level of the details. Usually error, warning or informational system service messages are reported, however more detailed Debug level messages can be reported also. The more detailed system messages are reported, the greater volume of log messages will be generated.

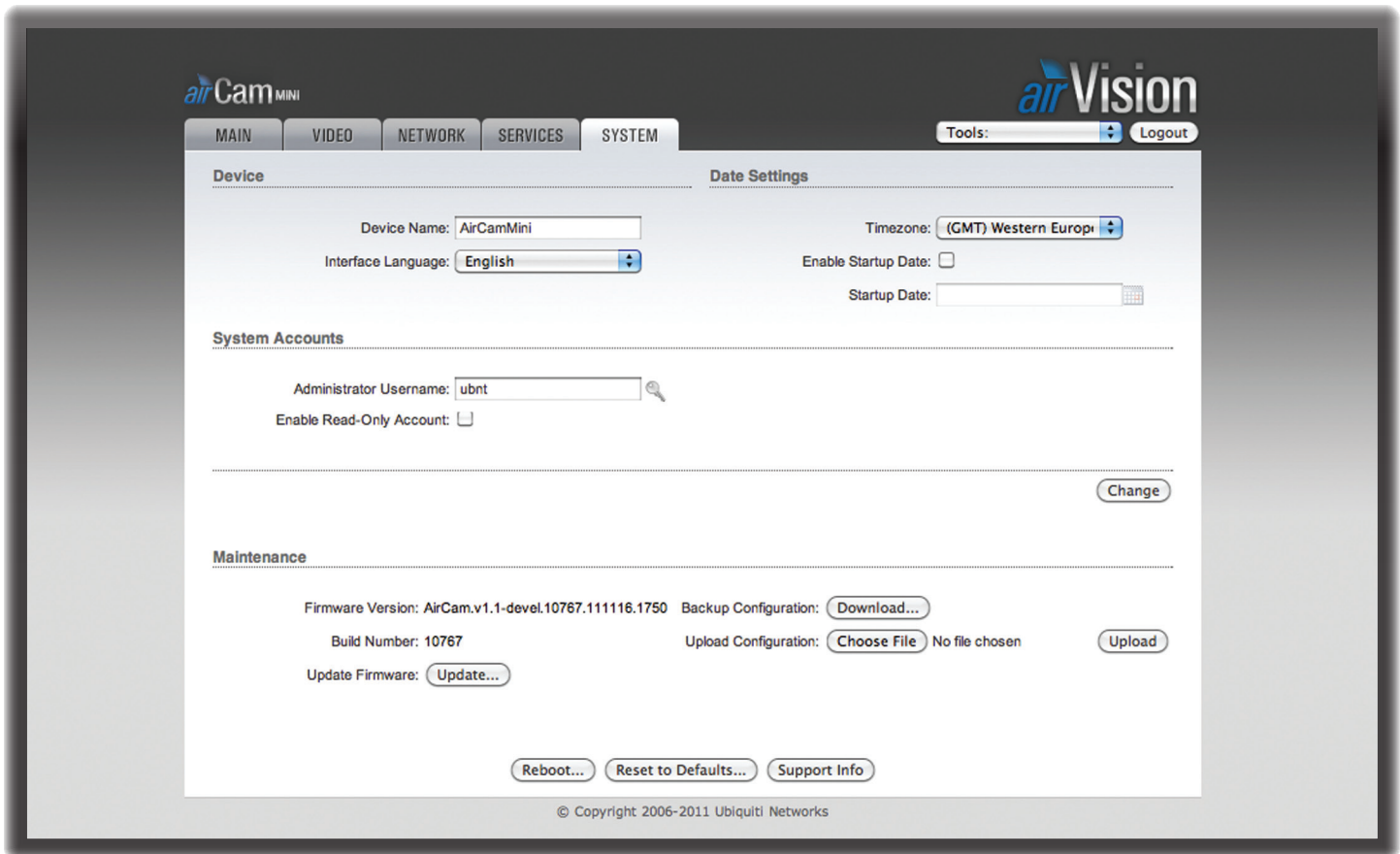

Chapter 8: System Tab

The *System* tab contains controls for airCam Mini Device Settings, Date Settings, System Accounts, Configuration Management, and Device Maintenance.

Device

Device Name (Host name) is the system wide device identifier. It is reported by the SNMP Agent to authorized management stations. Device Name will be represented in popular Router Operating Systems registration screens and discovery tools.



Device Name Specifies the system identity.

Interface Language Allows you to select the language displayed in the management interface. *English* is the default language.

Additional language profiles may be uploaded.

Refer to our wiki page at the following URL:

[www.ubnt.com/wiki/How to import Language Profile](http://www.ubnt.com/wiki/How_to_import_Language_Profile)

Date Settings

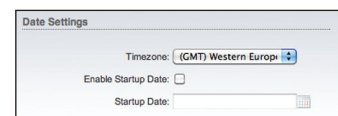

Timezone Specifies the timezone according to GMT (Greenwich Mean Time).

Enable Startup Date When enabled, you are able to modify the device's startup date.

- **Startup Date** Specifies the device's startup date. You can select a date by clicking the **Calendar** icon or typing it in manually. Type the date in the following format: 2 digit month/2 digit day/4 digit year. An example would be for May 20th, 2010 you would type **05/20/2010**

System Accounts

In this section you can modify the administrator password to protect your device from unauthorized configuration. The default administrator's password should be changed on the very first system setup:



Administrator Username Specifies the name of the system user.

Key button Press this button in order to change the administrator password.

- **Current Password** Enter the current password associated with the administrator account. It is required to change the *Password* or *Administrator Username*.
- **New Password** Enter the new password for the administrator account.
- **Verify New Password** Re-enter the new password for the administrator account.



Note: Password length is 8 characters maximum, passwords exceeding 8 characters will be truncated.

Enable Read-Only Account Click to enable the read-only account and configure the username and password to protect your device from unauthorized access. The default option is *disabled*.

- **Read-Only Username** Specifies the name of the system user.
- **Key button** Press this button in order to change the Read-only password.
 - **New Password** New password used for read-only administrator authentication should be specified.
 - **Show** Check this to display the read-only password characters you have typed.

Change Click to save changes to any of the fields on the *System* tab.

Maintenance

The controls in this section are dedicated for the device maintenance routines: rebooting, resetting, generating of the support information report.

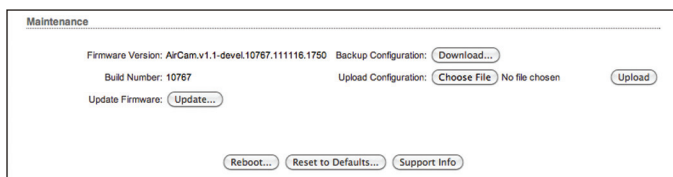

Firmware Version Shows the current firmware version.

Build Number Displays the build number of the firmware version loaded.

Update Firmware Click **Update** to open the *Firmware Upload* window to select and upload new firmware. For firmware update instructions, refer to **“Updating the Firmware” on page 20**.

Backup Configuration Click **Download** to download the current system configuration file.

Upload Configuration Click **Choose File** to navigate to and select the new configuration file or specify the full path to the configuration file location. Click **Upload** to use a previously downloaded configuration file to the system.



Note: A new configuration is active after clicking **Apply** and the system reboot cycle is completed. The previous system configuration is deleted after you click **Apply**. It is highly recommended to backup the system configuration before uploading the new configuration.

Reboot Click *Reboot* in order to initiate the full reboot cycle of the device. Reboot is the same as the hardware reboot which is similar to the power off - power on cycle. The system configuration is not modified after the reboot cycle completes. Any non-applied changes will be lost.

Reset to Defaults Use this to reset the airCam Mini to the factory default settings. This option will reboot the airCam Mini and all factory default settings will be restored. You may want to use the *Backup Configuration* option to download your current settings before selecting this option.

Support Info This will generate a support information file that the Ubiquiti support engineers can use when providing customer support. This file only needs be generated at their request.

Updating the Firmware



Note: The system configuration is preserved while the device is updated with new firmware but it is still a good idea to download a backup configuration before updating the firmware.

To update the firmware, perform the following steps:

1. Download the firmware file from www.ubnt.com.
2. Go to the **System** tab and click **Update** next to *Update Firmware*.

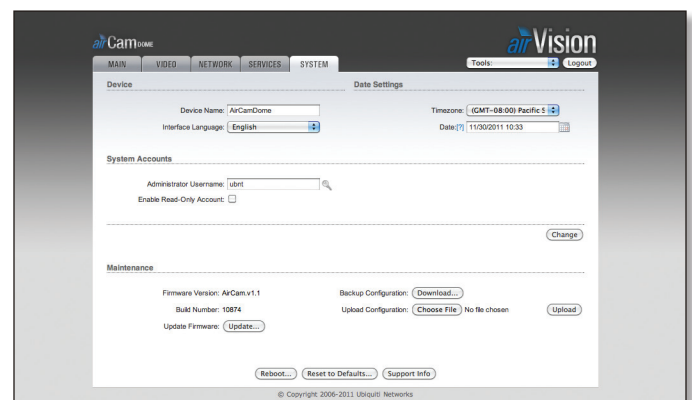

3. Click **Choose File**.

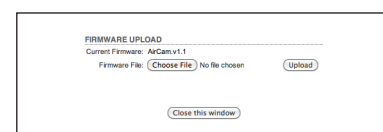

4. Select the firmware file and click **Open**.

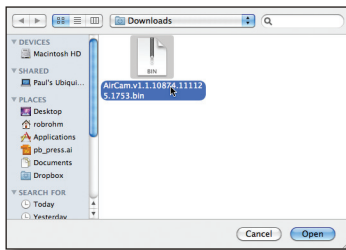

5. Click **Upload**.

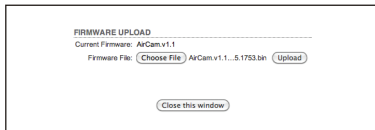

6. The *Current Firmware Version* and *Uploaded Firmware Version* will appear. Click the **Update** button to proceed with the firmware upgrade routine (new firmware image should be uploaded into the system first). Please be patient, as the firmware upgrade routine can take 3-7 minutes. The airCam Mini will be inaccessible until the firmware upgrade routine is completed.

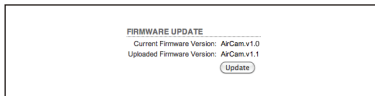

7. The firmware update progress bar will be displayed.

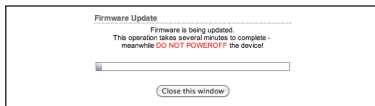

! **Important:** Do not switch off, do not reboot and do not disconnect the airCam Mini from the power supply during the firmware upgrade process as these actions will damage the device!

8. Once the firmware has been updated the *Firmware Update* window will close and the login screen will appear. Login and verify the firmware version.

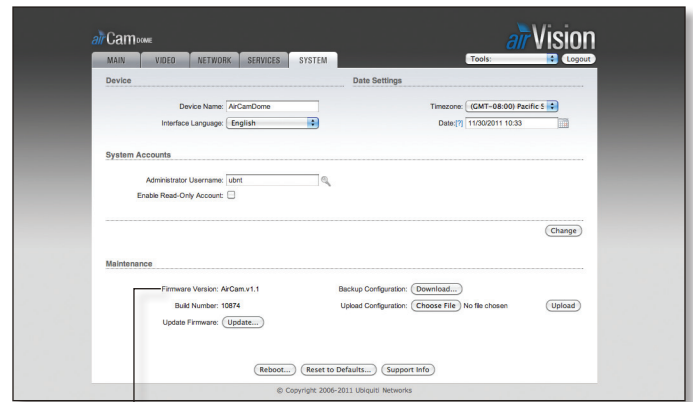

Firmware Version

Appendix A: Specifications

airCam Mini Specifications	
Dimensions	550 x 550 x 1220 mm
Weight	166 g
Ports	(1) 10/100 Ethernet, microSD card slot
Sensor	Progressive Scan RGB CMOS ¼"
Lens	3.6 mm/ F2.8
Horizontal of View	52°
Ethernet Ports	Auto MDIX, autosensing 10/100 Mbps
Power LED	Orange
Link/Active LED	Green
Buttons	Factory Reset Button
Power Method	Passive Power over Ethernet (12-24V)
Power Supply	24V/0.5A PoE Adapter included
Maximum Power Consumption	3 Watts
Certifications	CE, FCC, IC
Mounting	Desk Mount
Operating Temperature	0 to 40° C (32 to 104° F)
Operating Humidity	20 - 80% Noncondensing

Video	
Video Compression	H.264/MPEG-4/MJPEG
Resolution	1MP/HDTV 720p
Maximum Frame Rate	30 FPS
Image Setting	Brightness, Contrast, Sharpness, Saturation, Mirror, Flip, Noise Reduction, 50Hz/60Hz

Audio	
Microphone	ECM (Omni.); Sensitivity=-42±3dB ; S/N=60dBA

General	
Processor	ARM-based 32-bit RISC
Memory	128MB DDR2 SDRAM, 8MB Flash
Local Storage	microSD Card Slot (Card not included)
Maximum Active Array Size	1280x800
View Angle	52° (H) 34° (V) 59° (D)

Network	
Security	Multiple user access levels with password protection, User access log
Supported Protocols	IPv4/v6, HTTP, UPnP, DNS, NTP, RTSP, DHCP, TCP, UDP, IGMP, RTP, ICMP, ARP

Appendix B: Safety Notices

1. Read, follow, and keep these instructions.
2. Heed all warnings.
3. Only use attachments/accessories specified by the manufacturer.



WARNING: Do not use this product in location that can be submerged by water.



WARNING: Avoid using this product during an electrical storm. There may be a remote risk of electric shock from lightning.

Electrical Safety Information

1. Compliance is required with respect to voltage, frequency, and current requirements indicated on the manufacturer's label. Connection to a different power source than those specified may result in improper operation, damage to the equipment or pose a fire hazard if the limitations are not followed.
2. There are no operator serviceable parts inside this equipment. Service should be provided only by a qualified service technician.
3. This equipment is provided with a detachable power cord which has an integral safety ground wire intended for connection to a grounded safety outlet.
 - a. Do not substitute the power cord with one that is not the provided approved type. Never use an adapter plug to connect to a 2-wire outlet as this will defeat the continuity of the grounding wire.
 - b. The equipment requires the use of the ground wire as a part of the safety certification, modification or misuse can provide a shock hazard that can result in serious injury or death.
 - c. Contact a qualified electrician or the manufacturer if there are questions about the installation prior to connecting the equipment.
 - d. Protective earthing is provided by Listed AC adapter. Building installation shall provide appropriate short-circuit backup protection.
 - e. Protective bonding must be installed in accordance with local national wiring rules and regulations.

Appendix C: Warranty

General Warranty

UBIQUITI NETWORKS, Inc (“UBIQUITI NETWORKS”) represents and warrants that the Products furnished hereunder shall be free from defects in material and workmanship for a period of one (1) year from the date of shipment by UBIQUITI NETWORKS under normal use and operation. UBIQUITI NETWORKS sole and exclusive obligation under the foregoing warranty shall be to repair or replace, at its option, any defective Product that fails during the warranty period. The expense of removal and reinstallation of any item is not included in this warranty.

The foregoing warranty is exclusive and in lieu of all other warranties, express or implied, including the implied warranties of merchantability and fitness for a particular purpose and any warranties arising from a course of dealing, usage or trade practice with respect to the products. Repair or replacement in the manner provided herein shall be the sole and exclusive remedy of Buyer for breach of warranty and shall constitute fulfillment of all liabilities of UBIQUITI NETWORKS with respect to the quality and performance of the Products. UBIQUITI NETWORKS reserves the right to inspect all defective Products (which must be returned by Buyer to UBIQUITI NETWORKS factory freight prepaid).

No Products will be accepted for replacement or repair without obtaining a Return Materials Authorization (RMA) number from UBIQUITI NETWORKS. Products returned without an RMA number will not be processed and will be returned to Buyer freight collect. UBIQUITI NETWORKS shall have no obligation to make repairs or replacement necessitated by catastrophe, fault, negligence, misuse, abuse, or accident by Buyer, Buyer’s customers or any other parties. The warranty period of any repaired or replaced. Product shall not extend beyond its original term.

Warranty Conditions

The foregoing warranty shall apply only if:

- (I) The Product has not been subjected to misuse, neglect or unusual physical, electrical or electromagnetic stress, or some other type of accident.
- (II) No modification, alteration or addition has been made to the Product by persons other than UBIQUITI NETWORKS or UBIQUITI NETWORKS’S authorized representatives or otherwise approved by UBIQUITI NETWORKS.
- (III) The Product has been properly installed and used at all times in accordance, and in all material respects, with the applicable Product documentation.
- (IV) All Ethernet cabling runs use CAT5 (or above) shielded cabling.

Disclaimer

UBIQUITI NETWORKS does not warrant that the operation of the products is error-free or that operation will be uninterrupted. In no event shall UBIQUITI NETWORKS be responsible for damages or claims of any nature or description relating to system performance, including coverage, buyer’s selection of products for buyer’s application and/or failure of products to meet government or regulatory requirements.

Returns

In the unlikely event a defect occurs, please work through the dealer or distributor from which this product was purchased.

Appendix D: Compliance Information

Installer Compliance Responsibility

Devices must be professionally installed and it is the professional installer's responsibility to make sure the device is operated within local country regulatory requirements.

FCC

Changes or modifications not expressly approved by the party responsible for compliance could void the user's authority to operate the equipment.

NOTE: This equipment has been tested and found to comply with the limits for a Class A digital device, pursuant to part 15 of the FCC Rules. These limits are designed to provide reasonable protection against harmful interference when the equipment is operated in a commercial environment. This equipment generates, uses, and can radiate radio frequency energy and, if not installed and used in accordance with the instruction manual, may cause harmful interference to radio communications. Operations of this equipment in a residential area is likely to cause harmful interference in which case the user will be required to correct the interference at his own expense.

RF Exposure Warning

The transceiver described here emits radio frequency energy. Although the power level is low, the concentrated energy from a directional antenna may pose a health hazard. Do not allow people to come closer than 20 cm to the antenna when the transmitter is operating.

Additional information on RF exposure is available on the Internet at www.fcc.gov/oet/info/documents/bulletins

L'émetteur-récepteur décrit ici émet de l'énergie de fréquence radio. Bien que le niveau de puissance est faible, l'énergie concentrée à partir d'une antenne directionnelle peut présenter un danger pour la santé. Ne pas permettre aux gens de se rapprocher de 20 cm à l'antenne lorsque l'émetteur est en marche.

Des renseignements supplémentaires sur l'exposition aux RF est disponible sur Internet à www.fcc.gov/oet/info/documents/bulletins

Industry Canada

This Class A digital apparatus complies with Canadian ICES-003. Operation is subject to the following two conditions:

1. This device may not cause interference, and
2. This device must accept any interference, including interference that may cause undesired operation of the device.

To reduce potential radio interference to other users, the antenna type and its gain should be so chosen that the equivalent isotropically radiated power (e.i.r.p.) is not more than that permitted for successful communication.

Cet appareil numérique de la classe A est conforme à la norme NMB-003 Canada. Son fonctionnement est soumis aux deux conditions suivantes:

1. Cet appareil ne peut pas provoquer d'interférences et
2. Cet appareil doit accepter toute interférence, y compris les interférences susceptibles de provoquer un fonctionnement du dispositif.

Pour réduire le risque d'interférence aux autres utilisateurs, l'antenne type et son gain doivent être choisies de façon que l'équivalent puissance isotrope rayonnée équivalente (pire) n'est pas plus que cela autorisé pour une communication réussie.

CE Marking

CE marking on this product represents the product is in compliance with all directives that are applicable to it.

Alert sign! Follows CE marking

Alert sign must be indicated if a restriction on use applied to the product and it must follow the CE marking.



NB-Identification number (if there is any)

Notified body number is indicated if it is involved in the conformity assessment procedure.



Please check the CE mark on the product label to find out which notified body was involved during assessment.

RoHS/WEEE Compliance Statement



English

European Directive 2002/96/EC requires that the equipment bearing this symbol on the product and/or its packaging must not be disposed of with unsorted municipal waste. The symbol indicates that this product should be disposed of separately from regular household waste streams. It is your responsibility to dispose of this and other electric and electronic equipment via designated collection facilities appointed by the government or local authorities. Correct disposal and recycling will help prevent potential negative consequences to the environment and human health. For more detailed information about the disposal of your old equipment, please contact your local authorities, waste disposal service, or the shop where you purchased the product.

Deutsch

Die Europäische Richtlinie 2002/96/EC verlangt, dass technische Ausrüstung, die direkt am Gerät und/oder an der Verpackung mit diesem Symbol versehen ist, nicht zusammen mit unsortiertem Gemeindeabfall entsorgt werden darf. Das Symbol weist darauf hin, dass das Produkt von regulärem Haushaltsmüll getrennt entsorgt werden sollte. Es liegt in Ihrer Verantwortung, dieses Gerät und andere elektrische und elektronische Geräte über die dafür zuständigen und von der Regierung oder örtlichen Behörden dazu bestimmten Sammelstellen zu entsorgen. Ordnungsgemäßes Entsorgen und Recyceln trägt dazu bei, potentielle negative Folgen für Umwelt und die menschliche Gesundheit zu vermeiden. Wenn Sie weitere Informationen zur Entsorgung Ihrer Altgeräte benötigen, wenden Sie sich bitte an die örtlichen Behörden oder städtischen Entsorgungsdienste oder an den Händler, bei dem Sie das Produkt erworben haben.

Español

La Directiva 2002/96/CE de la UE exige que los equipos que lleven este símbolo en el propio aparato y/o en su embalaje no deben eliminarse junto con otros residuos urbanos no seleccionados. El símbolo indica que el producto en cuestión debe separarse de los residuos domésticos convencionales con vistas a su eliminación. Es responsabilidad suya desechar este y cualesquiera otros aparatos eléctricos y electrónicos a través de los puntos de recogida que ponen a su disposición el gobierno y las autoridades locales. Al desechar y reciclar correctamente estos aparatos estará contribuyendo a evitar posibles consecuencias negativas para el medio ambiente y la salud de las personas. Si desea obtener información más detallada sobre la eliminación segura de su aparato usado, consulte a las autoridades locales, al servicio de recogida y eliminación de residuos de su zona o pregunte en la tienda donde adquirió el producto.

Français

La directive européenne 2002/96/CE exige que l'équipement sur lequel est apposé ce symbole sur le produit et/ou son emballage ne soit pas jeté avec les autres ordures ménagères. Ce symbole indique que le produit doit être éliminé dans un circuit distinct de celui pour les déchets des ménages. Il est de votre responsabilité de jeter ce matériel ainsi que tout autre matériel électrique ou électronique par les moyens de collecte indiqués par le gouvernement et les pouvoirs publics des collectivités territoriales. L'élimination et le recyclage en bonne et due forme ont pour but de lutter contre l'impact néfaste potentiel de ce type de produits sur l'environnement et la santé publique. Pour plus d'informations sur le mode d'élimination de votre ancien équipement, veuillez prendre contact avec les pouvoirs publics locaux, le service de traitement des déchets, ou l'endroit où vous avez acheté le produit.

Italiano

La direttiva europea 2002/96/EC richiede che le apparecchiature contrassegnate con questo simbolo sul prodotto e/o sull'imballaggio non siano smaltite insieme ai rifiuti urbani non differenziati. Il simbolo indica che questo prodotto non deve essere smaltito insieme ai normali rifiuti domestici. È responsabilità del proprietario smaltire sia questi prodotti sia le altre apparecchiature elettriche ed elettroniche mediante le specifiche strutture di raccolta indicate dal governo o dagli enti pubblici locali. Il corretto smaltimento ed il riciclaggio aiuteranno a prevenire conseguenze potenzialmente negative per l'ambiente e per la salute dell'essere umano. Per ricevere informazioni più dettagliate circa lo smaltimento delle vecchie apparecchiature in Vostro possesso, Vi invitiamo a contattare gli enti pubblici di competenza, il servizio di smaltimento rifiuti o il negozio nel quale avete acquistato il prodotto.

Appendix E: Declaration of Conformity

Česky [Czech]	UBIQUITI NETWORKS tímto prohlašuje, že tento UBIQUITI NETWORKS device, je ve shodě se základními požadavky a dalšími příslušnými ustanoveními směrnice 1999/5/EC.	Malti [Maltese]	Hawnhekk, UBIQUITI NETWORKS, jiddikjara li dan UBIQUITI NETWORKS device, jikkonforma mal- ti ijjiet essenzjali u ma provvedimenti o rajn rilevanti li hemm fid-Dirrettiva 1999/5/EC.
Dansk [Danish]	Undertegnede UBIQUITI NETWORKS erklærer herved, at følgende udstyr UBIQUITI NETWORKS device, overholder de væsentlige krav og øvrige relevante krav i direktiv 1999/5/EF.	Norsk [Norwegian]	UBIQUITI NETWORKS erklærer herved at utstyret UBIQUITI NETWORKS device, er i samsvar med de grunnleggende krav og øvrige relevante krav i direktiv 1999/5/EF.
Nederlands [Dutch]	Hierbij verklaart UBIQUITI NETWORKS dat het toestel UBIQUITI NETWORKS device, in overeenstemming is met de essentiële eisen en de andere relevante bepalingen van richtlijn 1999/5/EG. Bij deze verklaart UBIQUITI NETWORKS dat deze UBIQUITI NETWORKS device, voldoet aan de essentiële eisen en aan de overige relevante bepalingen van Richtlijn 1999/5/EC.	Slovensky [Slovak]	UBIQUITI NETWORKS týmto vyhlasuje, že UBIQUITI NETWORKS device, spĺa základn� poiadavky a v etky prislun� ustanovenia Smernice 1999/5/ES.
English	Hereby, UBIQUITI NETWORKS, declares that this UBIQUITI NETWORKS device, is in compliance with the essential requirements and other relevant provisions of Directive 1999/5/EC.	Svenska [Swedish]	H�rmed intyggar UBIQUITI NETWORKS att denna UBIQUITI NETWORKS device, st�r i �verensst�mmelse med de v�sentliga egenskapskrav och �vriga relevanta best�mmelser som framg�r av direktiv 1999/5/EG.
Eesti [Estonian]	K�esolevaga kinnitab UBIQUITI NETWORKS seadme UBIQUITI NETWORKS device, vastavust direktiivi 1999/5/E� p�hin�uetele ja nimetatud direktiivist tulenevatele teistele asjakohastele s�tetele.	Espa�ol [Spanish]	Por medio de la presente UBIQUITI NETWORKS declara que el UBIQUITI NETWORKS device, cumple con los requisitos esenciales y cualesquiera otras disposiciones aplicables o exigibles de la Directiva 1999/5/CE.
Suomi [Finnish]	UBIQUITI NETWORKS vakuuttaa t�ten ett� UBIQUITI NETWORKS device, tyyppinen laite on direktiivin 1999/5/EY oleellisten vaatimusten ja sit� koskevien direktiivin muiden ehtojen mukainen.	Polski [Polish]	Niniejszym, firma UBIQUITI NETWORKS o wiadcza, e produkt serii UBIQUITI NETWORKS device, spełnia zasadnicze wymagania i inne istotne postanowienia Dyrektywy 1999/5/EC.
Fran�ais [French]	Par la pr�sente UBIQUITI NETWORKS d�clare que l'appareil UBIQUITI NETWORKS device est conforme aux exigences essentielles et aux autres dispositions pertinentes de la directive 1999/5/CE. Par la pr�sente, UBIQUITI NETWORKS d�clare que ce UBIQUITI NETWORKS device, est conforme aux exigences essentielles et aux autres dispositions de la directive 1999/5/CE qui lui sont applicables.	Portugu�s [Portuguese]	UBIQUITI NETWORKS declara que este UBIQUITI NETWORKS device, est� conforme com os requisitos essenciais e outras disposi��es da Directiva 1999/5/CE.
Deutsch [German]	Hiermit erkl�rt UBIQUITI NETWORKS, dass sich diese UBIQUITI NETWORKS device, in �bereinstimmung mit den grundlegenden Anforderungen und den anderen relevanten Vorschriften der Richtlinie 1999/5/EG befindet". (BMW) Hiermit erkl�rt UBIQUITI NETWORKS die �bereinstimmung des Ger�tes UBIQUITI NETWORKS device, mit den grundlegenden Anforderungen und den anderen relevanten Festlegungen der Richtlinie 1999/5/EG. (Wien)	Rom�n� [Romanian]	Prin prezenta, declar�m c� acest produs este �n conformitate cu cerin�ele esen�iale �i cu alte prevederi relevante din Directiva 1999/5/CE.
Ελληνική [Greek]	ΜΕ ΤΗΝ ΠΑΡΟΥΣΑ UBIQUITI NETWORKS ΔΗΛΩΝΕΙ ΟΤΙ UBIQUITI NETWORKS device, ΣΥΜΜΟΡΦΩΝΕΤΑΙ ΠΡΟΣ ΤΙΣ ΟΥΣΙΩΔΕΙΣ ΑΠΑΙΤΗΣΕΙΣ ΚΑΙ ΤΙΣ ΛΟΙΠΕΣ ΣΧΕΤΙΚΕΣ ΔΙΑΤΑΞΕΙΣ ΤΗΣ ΟΔΗΓΙΑΣ 1999/5/ΕΚ.		
Magyar [Hungarian]	Alulirott, UBIQUITI NETWORKS nyilatkozom, hogy a UBIQUITI NETWORKS device, megfelel a vonatkoz� alapvet� követelm�nyeknek �s az 1999/5/EC ir�nyelv egy�b el�ir�sainak.		
�slenska [Icelandic]	H�r me l sir UBIQUITI NETWORKS yfir v� a UBIQUITI NETWORKS device, er i samr�emi vi grunnkr�fur og a rar kr�fur, sem ger ar eru i tilskipun 1999/5/EC.		
Italiano [Italian]	Con la presente UBIQUITI NETWORKS dichiara che questo UBIQUITI NETWORKS device, � conforme ai requisiti essenziali ed alle altre disposizioni pertinenti stabilite dalla direttiva 1999/5/CE.		
Latviski [Latvian]	Ar o UBIQUITI NETWORKS deklar , ka UBIQUITI NETWORKS device, atbilst Direkt vas 1999/5/EK b tiskaj m pras b m un citiem ar to saist tajiem noteikumiem.		
Lietuvi�kai [Lithuanian]	UBIQUITI NETWORKS deklaruoja, kad �is UBIQUITI NETWORKS jrenginys atitinka esminius reikalavimus ir kitas 1999/5/EB Direktyvos nuostatas.		

Appendix F: Contact Information

Ubiquiti Networks Support

Ubiquiti Support Engineers are located in the U.S. and Europe and are dedicated to helping customers resolve software, hardware compatibility, or field issues as quickly as possible. We strive to respond to support inquiries within a 24 hour period.

Email: support@ubnt.com

Phone: 408-942-1153 (9 a.m. - 5 p.m. PST)

Online Resources

Wiki Page: www.ubnt.com/wiki

Support Forum: www.ubnt.com/forum

Downloads: www.ubnt.com/support/downloads



91 E. Tasman Drive
San Jose, CA 95134
www.ubnt.com

airCam and airVision are trademarks of Ubiquiti Networks, Inc.
The microSD mark and logo are trademarks of SD-3C, LLC

© 2011 Ubiquiti Networks, Inc. All rights reserved.